

RENAULT engine ECU decoding tool

1. Introduction

Have you ever seen where fuel injection ECU (Electronic Control Unit) on the Renault car is located? Yes, it is located in most vulnerable place in the engine compartment. In most cases even after medium-strength impact it became unusable because of mechanical damage and must be replaced. However from year 1994 most Renault cars are equipped with engine immobilizer system and it makes replacement of injection computer more complicated. There is no problem if replacement ECU is bought from Renault service dealer - it is sold with no immobilizer code stored, but replacing damaged computer with used one is impossible because of mismatch of unlocking codes.

And that was why an idea to create universal Renault ECU decoder revealed. Now if you have this tool you can take used injection computer and make it not coded as it was bought from Renault stores. Decoder has several modes of operation and covers all known petrol and diesel injection systems, introduced in range of year 1994-2001 **without intervention in to the ECU** (diesel coded anti-start valve as well). Systems, this tool was tested with, are listed below:

Petrol	Diesel
SIEMENS FENIX3	BOSCH MSA15.5 (DTI)
SIEMENS FENIX5	BOSCH EDC15C3 (DCI)
SIEMENS SIRIUS32	LUCAS DCU3R (1.9D)
SAGEM SAFIR (55pin)	Coded fuel cut-off valve (1.9D DDS)
SAGEM SAFIR2 (35pin)	
BOSCH MOTRONIC MP7.0	
MAGNETI MARELLI IAW 06R	

2. Operation

Front view of decoder presented in figure 1.

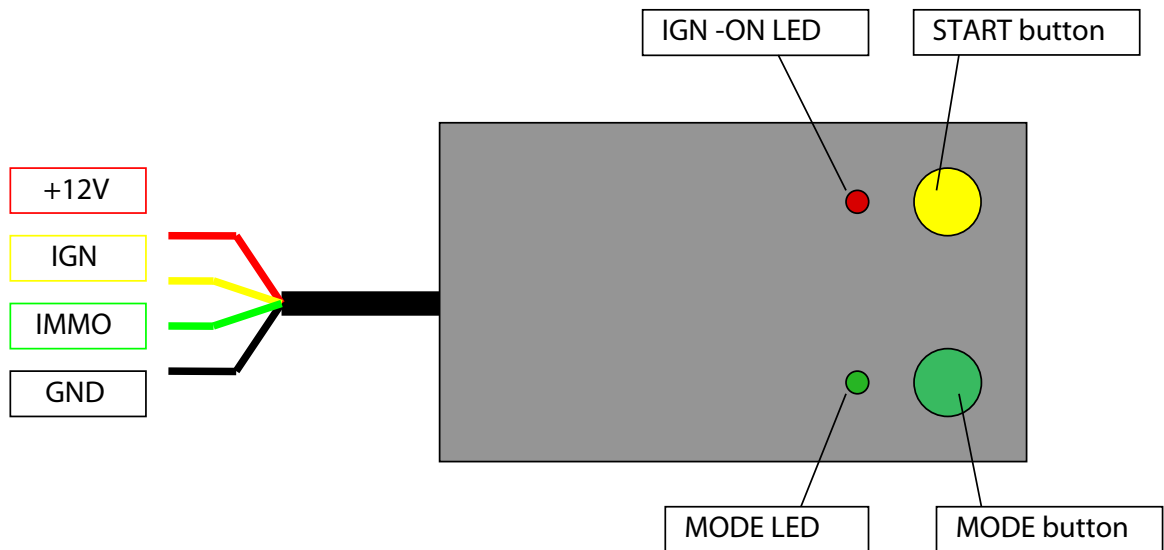

Figure 1. Front view.

MODE button is used to switch between operation modes. Mode can be changed only before pressing red START button. When decoding is in progress, MODE button becomes not operational.

There are 4 operation modes:

MODE	"MODE" LED
Standard	OFF
Advanced 1	ON
Advanced 2	Slow blinking
Semi-Auto (TYPE1 immo)	Fast blinking

All you have to do is connect decoder to the ECU you want to decode, according to connection diagram, select desired operation mode and press red START button. Which mode is to be selected depend on engine immobilizer type and several other factors, described below. Connect ground, battery +12V, MIL lamp and relay (if required). Use any 12V lamp (up to 2W), any relay with 12V coil and 12-14V power supply (over-current protection would be an advantage). Apply +12V IGN, lamp must blink. If lamp goes on and does not blink, ECU is already not coded or there is mistake in connection.

Connect decoder box as follows: red wire to ECU's +12V BAT, black wire to GND, yellow wire to ECU's +12V IGN (decoder switches +12V on and off by itself) and green wire to ECU's immobilizer input.

2.1. Immobilizer system overview

Renault immobilizer systems are divided in to three types - TYPE1, TYPE2 and TYPE3. This tool is able to decode ECUs with TYPE1 and TYPE2 immobilizer. Engine ECU from the TYPE2 system is decoded automatically with this tool; therefore TYPE1 ECU decoding is semi-automatic. It is very easy to find out what type of immobilizer is used with ECU you want to decode: ***if after ignition-on malfunction indicator lamp (MIL) illuminates for 2 seconds then starts to flash, this is TYPE2 immobilizer system; if after ignition-on malfunction indicator lamp (MIL) flashes immediately, this is TYPE1 immobilizer system.***

Immobilizer type	Prod. date	ECU <-> IMMO	ECU types
TYPE1	-01.96	Wire	Fenix3B, some of Fenix5 (produced in the beginning of year 1996)
TYPE2	02.96-2001	Wire	Fenix5, SIRIUS32, IAW 06R, MSA15.5, EDC15C3(-2001), SAFIR, SAFIR2, Lucas DCU3R
TYPE3	2001-	CAN bus	SIRIUS34, S2000, EDC15(2001-)

2.2. Decoding TYPE2 immobilizer system engine ECU

Decoding process is fully automated. On SIEMENS FENIX5, SIRIUS32 and coded solenoid valve select **Standard** type of operation (green LED off). Other systems may require **Advanced 1** or **Advanced 2** mode (especially engine control systems, where ignition-on signal to ECU is passed via fuel pump relay coil, e.g. **SAFIR2**), but is worth to try **Standard** mode first. Decoding in **Standard** mode takes about 1h 50min, in **Advanced 1** - almost 4h, in **Advanced 2** - more than 5h. In most cases 1h 50min is enough to make ECU not coded. Ignition is switched from off to on by decoding tool; red LED indicates ignition on. After decoding, ignition is switched off and green led is lit permanently.

After decoding, ECU is not coded and can be used on another car. If immobilizer system is ok (valid key), ECU retains new code from immobilizer control unit after ignition on. Most of decoded ECU can operate without immobilizer code stored (Fenix5, diesel coded solenoid valve, some of SIRIUS32,...), other require immobilizer code to be stored.

2.3. Decoding TYPE1 immobilizer system engine ECU

Select Semi-Auto operation mode (fast green LED blinking). Press START button. After every ignition-on, MIL immediately starts to blink fast. Watch the ECU MIL lamp and count number of ignition-on (start counting from 1). Note number of ignition-on cycles when MIL stops blinking for a while. Use **Immo1.exe** to convert this number to security code. For ex.: MIL stopped blinking on 89-th ignition-on: program calculates code 2232.

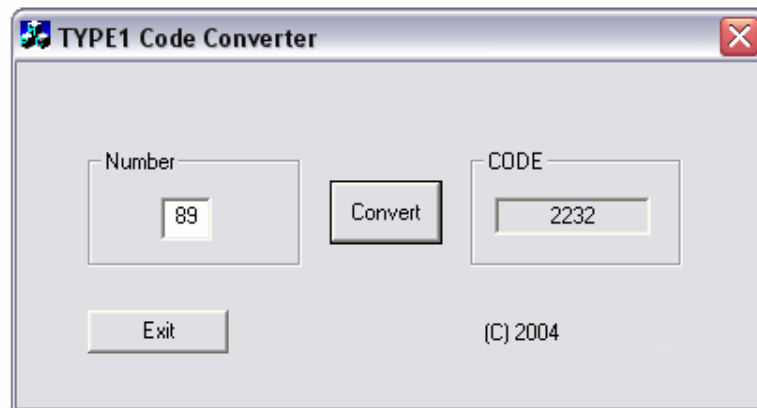

ECU is not decoded after this procedure; you only found out its security code! Count number can be in range 1-255. In worst case when MIL stops to blink on 255-th ignition-on, counting takes about 8 minutes.

Put ECU back to car and turn key to ignition-on. Injection fault lamp flashes quickly.

1. Depress and keep depressed accelerator pedal fully – injection fault lamp extinguishes. To enter security code use trip computer button on the end of wiper control stalk. This button is called ADAC button.
2. Press the button the same number of times as the first figure of the code, checking injection fault lamp illumination each time the switch is pressed.
3. Release the accelerator pedal: injection fault lamp flashes.

Repeat operations 1, 2 and 3 to enter in succession the three other digits of the code. When the code has been entered the injection fault lamp should be illuminated continuously for 2sec and then must to extinguish. ECU is no longer protected by immobilizer and is ready to retain new code. If injection fault lamp flashes, the code is incorrect. Switch off the ignition, switch it on again and repeat procedure for entering code.

Procedure for code entering can be performed without car as well. Accelerator pedal depressing-releasing emulate using throttle position potentiometer connected to the ECU, button connect between ground wire and immobilizer line (see wiring drawings).

3. Wiring drawings

Task of this chapter is to explain how to connect decoder box to engine control unit you want to decode.

3.1. *General*

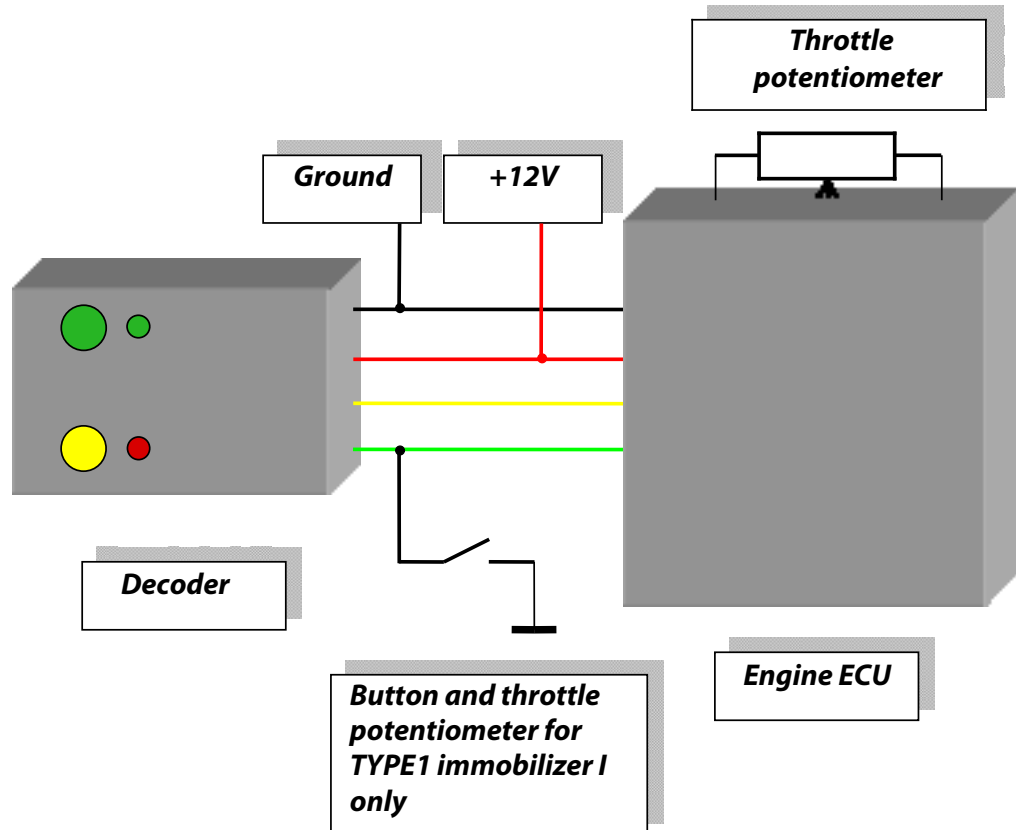

3.2. SIEMENS FENIX 3B

Siemens Fenix3B ECU with 35pin connector. It is used on LAGUNA, SAFRANE, R19, ESPACE, CLIO and on the others in the range of year 1994-1996.

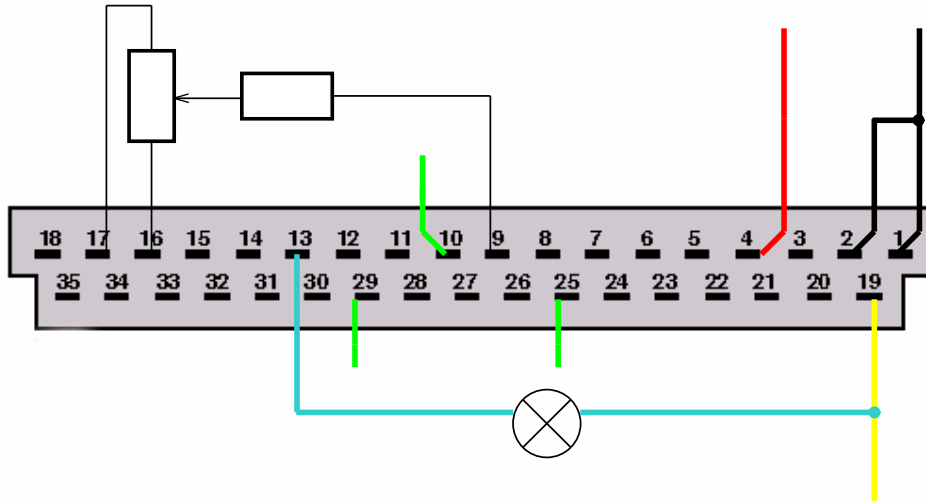

Pin	Description
1, 2	Ground
4	+12V Before Ignition (30)
19	+12V After Ignition (15)
13	Fault lamp
9, 16, 17	Throttle potentiometer (4k7 potentiometer and 10k resistor from slider to pin 9)
10	Immobilizer line for 1.8l ECU*
25	Immobilizer line for 2.0l ECU*
29	Immobilizer line for 1.4l ECU*

* Connect button and decoder output to corresponding pin according to engine type

3.3. SIEMENS FENIX 5

Siemens Fenix5 is rubber compound filled ECU with 55pin connector.

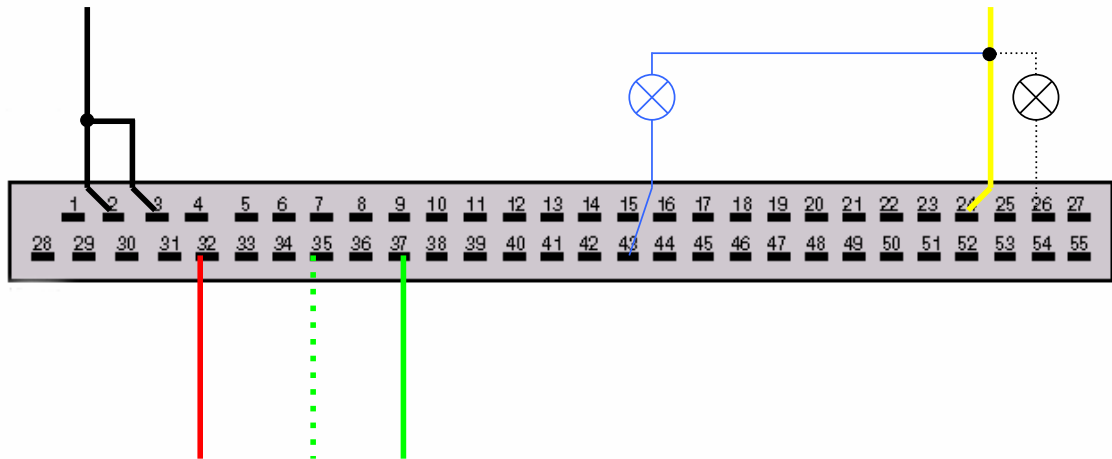

Pin	Description
2, 3	Ground
32	+12V Before Ignition (30)
24	+12V After Ignition (15)
43 - 1.4 and 1.6l; 26 - 1.8, 2.0 and 3.0l	Fault lamp
37 - 1.4 and 1.6l; 35 - 1.8, 2.0 and 3.0l	Immobilizer line

3.4. SIEMENS SIRIUS32

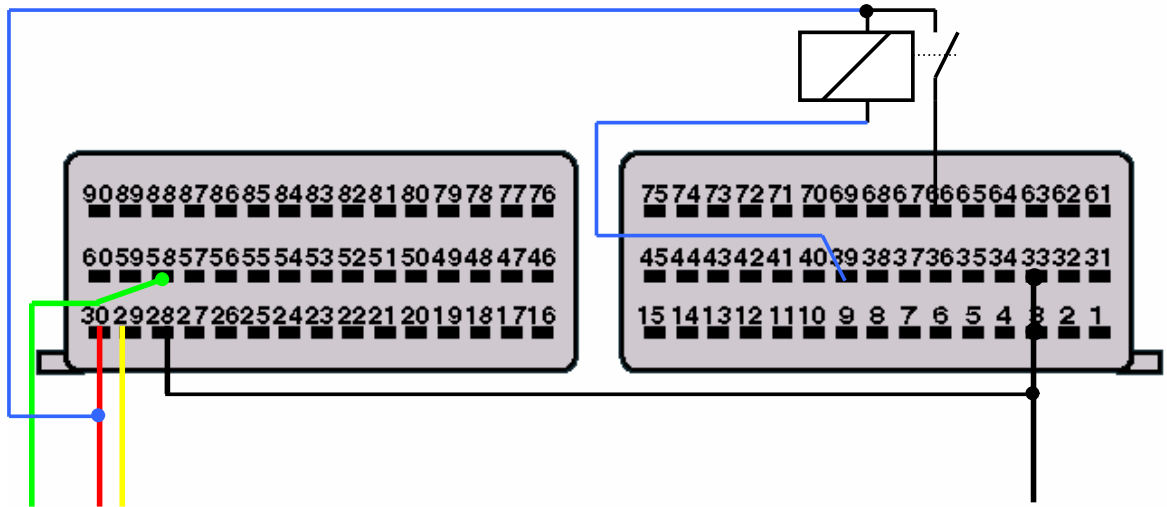

Pin	Description
3, 28, 33	Ground
30	+12V Before Ignition (30)
29	+12V After Ignition (15)
39	Main relay control
66	Feed from main relay
58	Immobilizer line

3.5. SAGEM SAFIR2

Sagem SAFIR2 is rubber compound filled ECU with 35pin connector.

Connect only three wires to decoder box: ground, immobilizer line and switched +12V. Connect decoder's red wire to constant +12V.

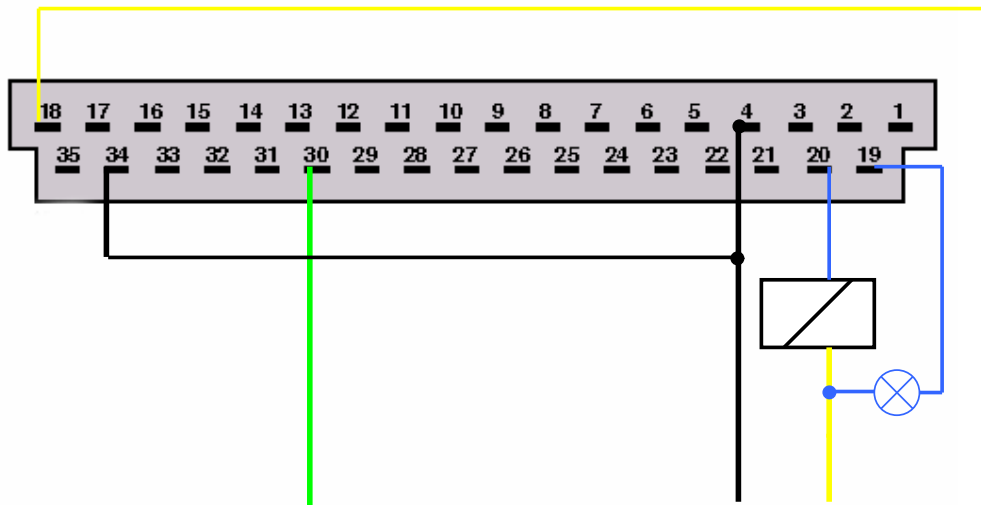

Pin	Description
4, 34	Ground
18, through relay coil to pin 20	+12V After Ignition (15)
19	Fault lamp
30	Immobilizer line

3.6. MAGNETI MARELLI IAW 06R (TWINGO 1.2I SPI)

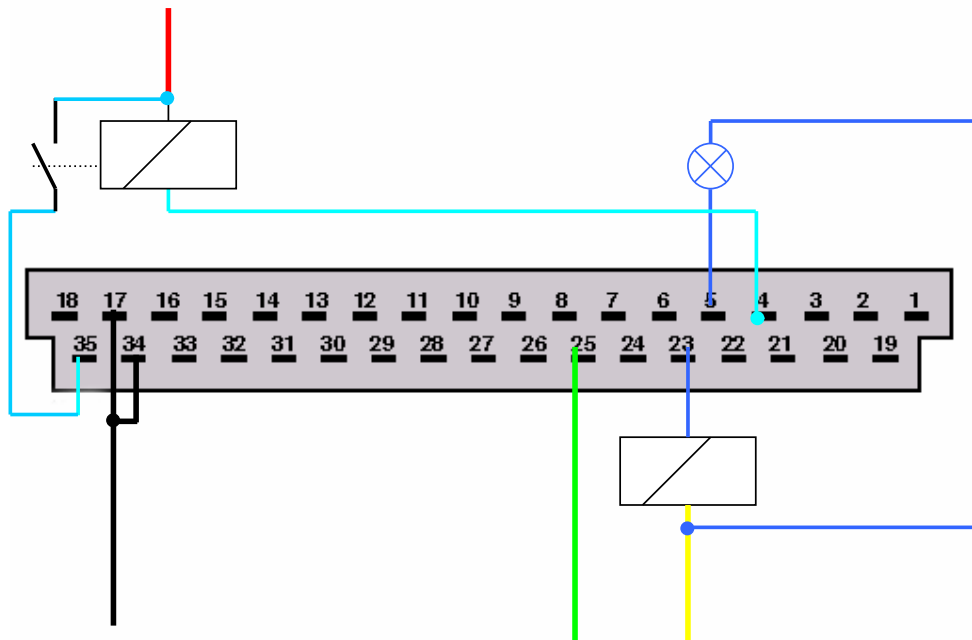

Pin	Description
17, 34	Ground
Through relay coil to pin 4	+12V Before Ignition (30)
Through relay coil to pin 23	+12V After Ignition (15)
5	Fault lamp
25	Immobilizer line

3.7. BOSCH MOTRONIC MP7.0

This ECU is used with 3.0l 24V engines

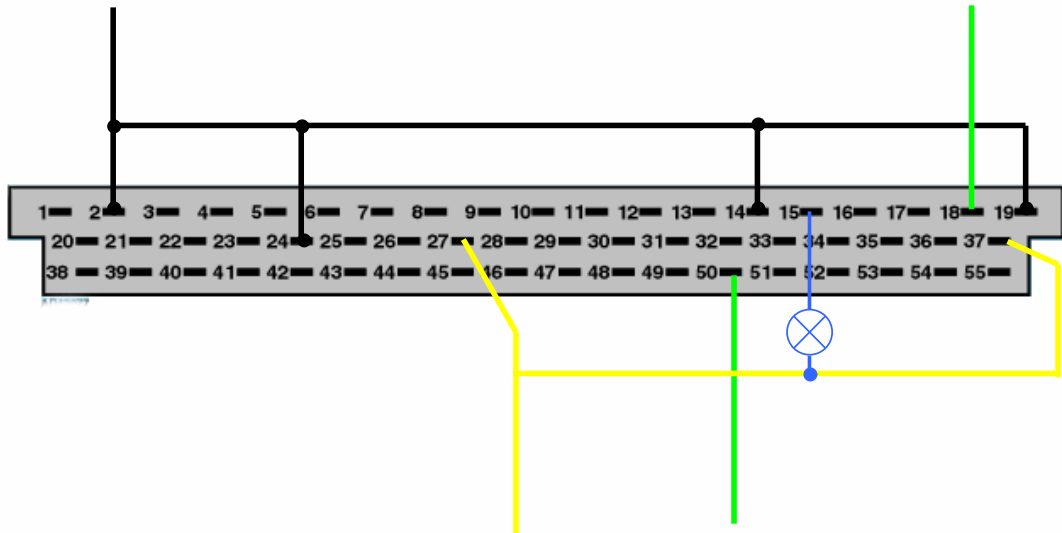

Pin	Description
2, 14, 19, 24	Ground
18	+12V Before Ignition (30)
27, 37	+12V After Ignition (15)
15	Fault lamp
50	Immobilizer line

3.8. BOSCH MSA15.5

Used with 1.9DTI engines.

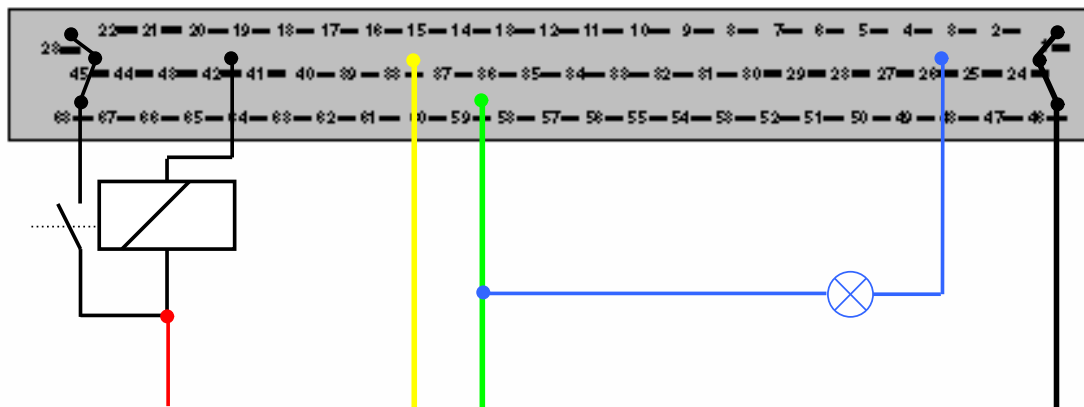

Pin	Description
1, 24, 46	Ground
Through relay coil to pin 42	+12V Before Ignition (30)
38	+12V After Ignition (15)
26	Fault lamp
59	Immobilizer line
42	Main relay control
23, 45, 68	Feed from main relay

3.9. **Coded diesel fuel cut-off valve DDE (integrated into diesel pump)**

Disconnect connector with 3 wires from diesel pump and connect decoder box as follows:

Pin	Description
3	Ground
2	+12V After Ignition (15)
1	Immobilizer line

If after applying +12V cut-off valve inside pump is actuated for 1sec then released - valve is coded, if remains actuated - not coded. If valve is not coded, it can be learnt with another code.

3.10. **LUCAS DCU3R (Clio II, Kangoo 1.9D)**

Pin	Description
78, 79	Ground
76, 77, 81	+12V After Ignition (15)
20	Immobilizer line